

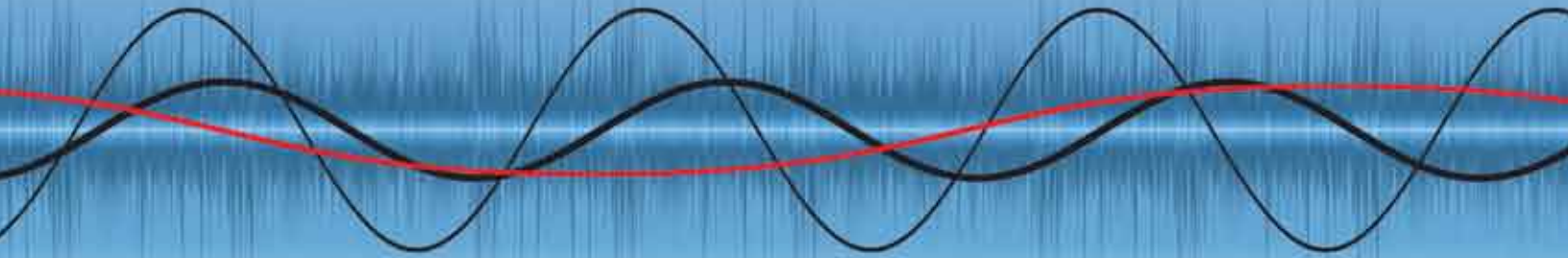

Bird Technologies®

www.birdrf.com



Multicouplers, TTA's & Preselectors

TTA, RECEIVER MULTICOUPLERS & PRESELECTORS

TABLE OF CONTENTS

Tower Top Amplifier System	Page 1
Rapid Deployment TTA	Page 5
Receiver Multicouplers	Page 7
Preselectors	Page 9

TOWER TOP AMPLIFIER SYSTEM

429-83H-01-T & 429-83H-01-M

Bird Technologies Group, TX RX Systems brand, compact Tower-Top Amplifier (TTA) system is a high performance, quadrature-coupled low noise amplifier (LNA) designed to increase the performance of a Base Transceiver Station (BTS) while ensuring reliable communications for critical Public Safety applications. This increase in sensitivity can make up for the imbalance between mobile and handheld users in critical systems.

The TTA system consists of two components: the Tower-Top Amplifier mounted close to the antenna and the Receiver Multicoupler base unit. To reduce the size of the TTA and simultaneously provide 120 dB of isolation of a TX carrier, filtering has been split between the TTA and the base unit.

Two independent LNA's, each powered by separate bias circuits, provides component redundancy as well as excellent intermodulation (IM) performance. Microprocessor-controlled fault detection circuitry provides continuous monitoring and switching of each quad-LNA while sending operational data to the base unit for at-a-glance status reporting and form C contact alarm switching.

For AISG/EIA-485 data communications between the TTA and base control unit, a custom PolyPhaser™ lightning protector and a CAT-5 cable are installed at the transmission line entry bulkhead/grounding plate. The surge protector not only passes the DC current that powers the TTA but also generates the low frequency subcarrier for AISG/EIA-485. If the data cable is damaged, removed or not installed, the TTA will continue to operate however, the status and alarm functions will not be available at the base. For testing and diagnosing problems on the main receive line, a test transmission line is required. The system will continue to operate if the test line is damaged or not installed however, an alarm will be continuously set.

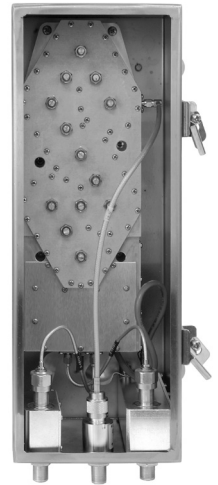

FEATURES

- Redundant quadrature LNA's and automatic solid-state back-up switching ensures reliable communications
- PolyPhaser™ impulse suppressors provide protection from lightning damage on all I/O ports
- AISG/EIA-485 compatible for data communications between TTA and Receiver Multicoupler
- RF test port enables gain, sensitivity and desensitization measurements from ground level
- Compact, weather-resistant stainless steel modified NEMA 4X enclosure
- Webpage user interface available for controlling and monitoring of amplifier currents, alarms and attenuators
- One rack-unit high Receiver Multicoupler (MCU)
- Multifunction LCD readout with multicolored LEDs for status reporting
- Form C contacts for fault reporting through a supervisory system
- Ethernet connector for fast ATP mode switching and alarm details

System Specifications

13 dB net gain and maximum 6 dB transmission line loss assumed

Bandwidth	792-824 MHz
System Noise Figure	2.9 dB Typ, 3.5dB Max
3rd Order IIP	> 15 dBm
TTA Net Gain	Fully settable by electronic attenuator
Rejection	110 dB min, 120 dB nominal at 776 and 851 MHz
Net Weight	30.5 lbs for TTA + MCU
Ship Weight	42 lbs

Product Description

TTA, 792-824 MHz, tower top box only

Part Number

429-83H-01-T

Receiver Multicoupler for TTA, 16-port, 792-824 MHz, to be used in conjunction with 429-83H-01-T, 90-240 VAC

429-83H-01-M

Receiver Multicoupler for TTA, 16-port, 792-824 MHz, 48 VDC

429-83H-01-M-48

Combined Tower Top and Base Deck Filter Response

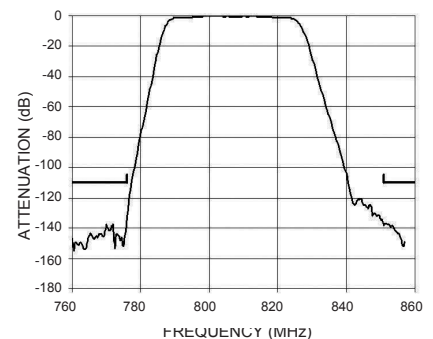

A steep skirted TEM bandpass filter in the tower box augmented by a ceramic filter in the base unit provide a selective 32 MHz system window.

TOWER TOP AMPLIFIER SYSTEM

429-83H-01-T & 429-83H-01-M

RF TEST PORT

Provides a path from the base control unit to an isolated 42 dB port at the input to the LNA. Operated via membrane switches on the front panel, the base control unit provides two test modes:

- Systems test - connects to 42 dB port on LNA while coupled to the preselector and receive antenna
- Desense test - LNA is switched to a 50-ohm load. Allows testing for external interference desensitization with minimal disruption to the system.

Test modes automatically time out back to Default mode after 5 minutes unless conducting ATP tests via the Ethernet interface.

ELECTRONIC PROGRAMMABLE ATTENUATORS

To optimize performance two attenuators are incorporated into the Receiver Multicoupler Unit and are accessible via membrane switches on the front panel. One attenuator is used to set the TTA System Net Gain. The second attenuator is used to compensate for multicoupler-to-receiver cable loss (zero multicoupler gain.)

AVAILABLE OPTIONS:

Rack-mounted narrow band filters to further limit the multi-coupler bandwidth

-48 Volt DC power operation

TOWER TOP AMPLIFIER SPECIFICATIONS

Frequency Range	792 - 824 MHz
Net Gain	23 dB
Noise Figure (Typ. / Max)	2.7 dB / 3.0 dB
Backup Amplifier Switching	Solid State RF Switch
Integrated Test Port Isolation	42 dB
Preselector Type Loss Rejection	7-pole TEM bandpass with cross-coupling < 0.8 dB > 60 dB @ 776 and 851MHz
LNA Type Gain Noise Figure 3rd Order Input IP	2-stage Quadrature integrated into filter 26 dB 1.2 dB +18 dBm
Impedance	50 ohms
Antenna Port VSWR	2 :1
Power Requirements	12 VDC @ 1.25 A
Lightning Protection	Impulse suppressor on all external connectors
Operating Temperature Range	-30°C to +60°C

MECHANICAL

Enclosure	Modified NEMA 4X: Stainless Steel Weather Resistant
Connectors	N - female
Dimensions (HWD) not including mounting tabs or connectors	18" x 6" x 6" (457 x 152 x 152 mm)
Net Weight	20 lbs (9.1 kg)

RECEIVER MULTICOUPLER / CONTROL UNIT SPECIFICATIONS

Frequency Range	792 - 824 MHz
Multicoupler Net Gain	+1 dB typ; 0 dB min
Distribution Amp Type Gain Noise Figure 1 dB Compression Point 3rd Order Output IP	Quadrature-Coupled Dual Stage 23 dB 4 dB +27 dBm +46 dBm
Number of outputs / Split Loss	16 or 32 / 18 dB
Impedance	50 ohms
VSWR	< 2:1
Connectors: To TTA To BTS Test Port Input	N - female BNC-female BNC - female
Net Gain Electronic Attenuator	0-15.5 dB in 0.5 dB steps
Distribution Amp Electronic Attenuator	0~3 dB in 0.5 dB steps
Alarm and Warning Contacts	Two Form C Contacts (Nominal 2A @ 30 VDC or 0.5A @ 125 VAC)
I/O	Ethernet
Power Requirements	90-240 VAC 50/60 Hz 180 mA @ 120 V (current draw is for base deck only, not including the power needed to run the tower top box).

Operating Temperature Range: at non-condensing humidity

MECHANICAL

Enclosure	Standard EIA 19" Rack Mounting
Connectors	N - female
Dimensions (HWD)	1 RU x 19" x 14" (38 x 483 x 356 mm)
Net Weight	10.5 lbs (4.8 kg)

TOWER TOP AMPLIFIER SYSTEM

429-83H-01-T & 429-83H-01-M

OPTIONAL FILTERS

Optional filters are available to provide a narrower window ahead of the receiver multicoupler in order to achieve better selectivity for the system.

Model Numbers	89-83F-02-03 89-83F-02-06 89-83F-02-09 89-83F-02-14	
Frequency Range		792-806 MHz
Pass Bandwidth	89-83F-02-03 89-83F-02-06 89-83F-02-09 89-83F-02-14	3 MHz 6 MHz 9 MHz 14 MHz
Typical Insertion Loss	89-83F-02-03 89-83F-02-06 89-83F-02-09 89-83F-02-14	2.0 dB 1.5 dB 1.0 dB 1.0 dB
Max. Insertion Loss @ Passband Edge	89-83F-02-03 89-83F-02-06 89-83F-02-09 89-83F-02-14	3.0 dB 2.0 dB 1.5 dB 1.5 dB
Typical Selectivity (dB @ MHz)	89-83F-02-03 89-83F-02-06 89-83F-02-09 89-83F-02-14	100 @ 766 & 851 100 @ 766 & 851 90 @ 766 & 851 80 @ 766 & 851
VSWR max.		1.5:1
RF Power		Rx only
Temperature Range		-30° to +60° C
Connectors		N(F)
Dimensions		2RU x 19" x 5"

Model Numbers	89-86A-02-03 89-86A-02-05 89-86A-02-10 89-86A-02-15 89-86A-02-18	
Frequency Range		806-824 MHz
Pass Bandwidth	89-86A-02-03 89-86A-02-05 89-86A-02-10 89-86A-02-15 89-86A-02-18	3 MHz 5 MHz 10 MHz 15 MHz 18 MHz
Typical Insertion Loss	89-86A-02-03 89-86A-02-05 89-86A-02-10 89-86A-02-15 89-86A-02-18	2.0 dB 1.5 dB 1.5 dB 1.0 dB <1.0 dB
Max. Insertion Loss @ Passband Edge	89-86A-02-03 89-86A-02-05 89-86A-02-10 89-86A-02-15 89-86A-02-18	3.0 dB 2.0 dB 2.0 dB 1.5 dB 1.25 dB
Typical Selectivity (dB @ MHz)	89-86A-02-03 89-86A-02-05 89-86A-02-10 89-86A-02-15 89-86A-02-18	100 @ 766 & 851 100 @ 766 & 851 95 @ 766 & 851 90 @ 766 & 851 90 @ 766 & 851
VSWR max.		1.5:1
RF Power		Rx only
Temperature Range		-30° to +60° C
Connectors		N(F)
Weight lbs (kg)	89-86A-02-03 89-86A-02-05 89-86A-02-10 89-86A-02-15 89-86A-02-18	7 (3.18) 7 (3.18) 6 (2.7) 7 (3.18) 7 (3.18)
Dimensions		2RU x 19" x 5"

RAPID DEPLOYMENT TOWER TOP AMPLIFIER SYSTEM

429-83H-01-RD

Bird Technologies Group, TX RX Systems brand, Rapid Deployment TTA is designed to enhance the operation of the temporary base station. The Rapid Deployment TTA will increase the receive sensitivity, often in excess of 10 dB, and can make up for the imbalance between mobile and handheld users. Often in emergency situations, any increase in "talk back" range can make the difference in mission critical communications.

The TTA system consists of two components: the Tower-Top Amplifier mounted close to the antenna and a Receiver Multicoupler base unit. The lightweight and rugged TTA is designed to reduce wind loading on mobile communications tower systems. In addition, the rapidly deployable package ensures quick and reliable communications in emergency situations. To reduce the size of the TTA and simultaneously provide 120 dB of isolation of a TX carrier, filtering has been split between the TTA and Receive Multicoupler base unit.

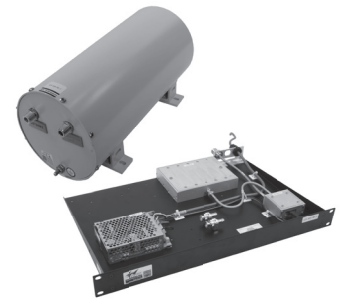

FEATURES

- Quadrature-coupled low noise amplifier (LNA) improves RX sensitivity
- PolyPhaser™ impulse suppressors provide protection from lightning damage
- High performance filtering in tower top and base deck
- RF bypass if DC power is interrupted
- Reduced wind loading with round TTA enclosure
- Quick installation
- Compact, light weight, weather-resistant enclosure
- One rack-unit high Receiver Multicoupler (MCU)

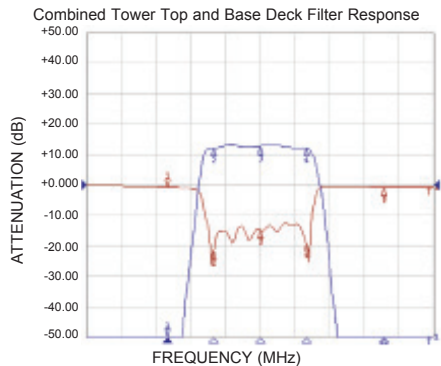

A steep skirted TEM bandpass filter in the tower box augmented by a ceramic filter in the base unit provide a selective 32 MHz system window.

RECEIVER SYSTEM SPECIFICATIONS

Frequency Range	792-824 MHz
Multicoupler Net Gain	-10 dB
Number of outputs	8
Impedance	50 ohms
VSWR	< 2:1
Connectors:	
To TTA	N - female
To BTS	BNC - female
Power Requirements	90-240 VAC 50/60 Hz 180 mA @ 120 V (current draw is for base deck only)
Operating Temp Range	0°C to +50°C
Range: at non-condensing humidity	
Enclosure	Standard EIA 19" Rack Mounting
Dimensions	1 RU x 19" x 14" (38 x 483 x 356 mm)
Net Weight	7.55 lbs

IDEAL FOR

- Temporary Basestations
- Transportable Command Centers
- Rapid Deployment Stations

TOWER TOP AMPLIFIER SYSTEM SPECIFICATIONS

Frequency Range	792-824 MHz
Net Gain	23 dB
Noise Figure (Typ./Max)	2.7 dB / 3.0 dB
Preselector Type	7-pole bandpass with cross-coupling
Loss	< 0.8 dB
Rejection	> 60 dB @ 776 and 851 MHz
LNA Type	2-stage Quadrature integrated into filter
Gain	26 dB
Noise Figure	1.2 dB
3rd Order Input IP	+18 dBm
Impedance	50 ohms
Antenna Port VSWR	< 2:1
Power Requirements	120 V @ 0.65 A
Lightning Protection	Impulse Suppressor on antenna port
Operating Temp Range	-30°C to +60°C
Enclosure	Aluminum canister foot mounting tabs
Connectors	N-Female
Dimensions (not including mounting tabs or connectors)	15" long x 6" diameter
Net Weight	13.1 lbs

SYSTEM SPECIFICATIONS

Bandwidth	792-824 MHz
System Noise Figure	2.9 dB Typ, 3.5dB Max
3rd Order IIP	> 15 dBm
Rejection	110 dB min, 120 dB nominal at 776 and 851 MHz
Net Weight	13.1 lbs

TOWER TOP AMPLIFIERS

792-901 MHz

TOWER TOP AMPLIFIER SYSTEMS

Bird Technologies Group, TX RX Systems brand, Tower-Top Amplifier (TTA) is an important system component in systems above 700 MHz. As the frequency rises, so does the loss of the coaxial cable feedline which connects the receive antenna to the system. A TTA places a high-performance Low-Noise Amplifier (LNA) as close to the receive antenna as practically possible to minimize feedline loss before amplification. This increase in sensitivity, often in excess of 10 dB, can make up for the imbalance between mobile and handheld users in critical systems. TX RX TTA's are designed with an integrated power source/controller, high-performance distribution amplifier and expandable 16-32 channel multicoupler, all in a 1-rack unit package. TX RX also manufactures various preselectors that are used with the TTA systems to protect your receivers from transmitter overload.

- Low noise figure, high intercept point LNA design
- Typically provides 10 dB receiver sensitivity improvement
- Wide choice of preselector filtering
- 700 MHz versions available, consult factory



421-FFF-10-18-16

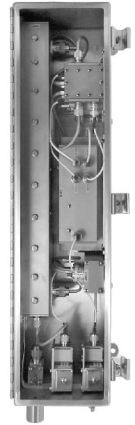

421-94C-XX-5-16N TTA Specifications

Noise Figure	3 dB typical, 4 dB max.
Net Gain	13 dB
3rd Order Input Intercept Point	+18 dBm min.
3rd Order Output Intercept Pt.	+35 dBm typ.
Bypass Insertion Loss	3 dB
Test Port Isolation	30 dB
Return Loss	12 dB
Operating Temperature	-30 to +60 C
Lightning Protection	Impulse suppression all ports
Connectors	N
Enclosure	NEMA 4X (Stainless Steel)
Dimensions	24"H x 6"W x 6"D
Net Weight	30 lbs.

421-94C-XX-5-16N Multicoupler/Controller Specifications

Noise Figure	3 dB
Distribution Amp 3rd order OIP	+44 dBm min.
Net Gain	2 dB typ.
Return Loss	14 dB
Operating Temperature	-10 to +50 C
Power Requirements	85-264 VAC, 0.5A, 47-63 Hz.
RF Connections to TTA	N
RF Test Port Input	-10 BNC
Mounting	Standard 19" EIA Rack
Dimensions	-9 1.75"H x 19"W x 14"D
	-10 3.5"H x 19"W x 14"D
Net Weight	15 lbs.

94C = 896-901 MHz

-10- means without test port

-09- means with test port

RECEIVER MULTICOUPLERS

118-901 MHz

COMPACT RECEIVER MULTICOUPLERS

Bird Technologies Group, TX RX Systems brand, broadband receiver multicouplers provide unequalled performance in a 1-rack unit (1-3/4 inch) space-saving package. The high-performance LNA's exhibit a very low noise figure while providing a (100% measured) 3rd order output intercept point in excess of +40 dBm. The multicouplers are designed with a minimum excess gain of 10 dB which gives maximum sensitivity in rural applications. All the units are designed for ease of expansion, with no change in system gain in most cases. Three basic models cover the most popular applications from 118 - 901 MHz.

Consult our comprehensive RF component and accessories catalog for receiver multicoupler systems components such as LNA's and power dividers for special needs you may have.

All TX RX Receiver multicouplers are easily expandable by either adding additional power dividers to the existing chassis or by addition of a 1-rack unit deck. The 16-channel BNC models have 2 terminated BNC connectors for non-invasive expansion of up to 16 additional outputs in 8-output blocks, with no change in performance or specifications. All necessary cables with attached connectors are included in each kit.



Model 42-83A-01

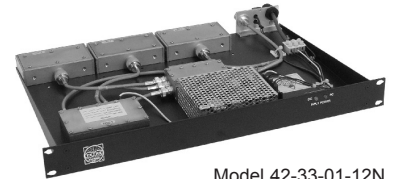

Model 42-33-01-12N

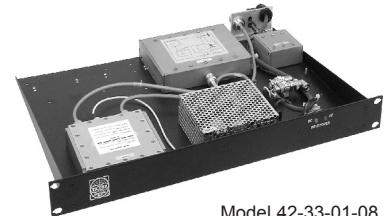

Model 42-33-01-08

Space-saving 19", 1 RU rack-mount design

TX RX-designed and manufactured high-performance LNA

Auto-Ranging AC and DC power: 85 - 264 VAC 50/60 Hz / 22 - 30 VDC

TECHNICAL SPECIFICATIONS

MODEL NUMBER	NUMBER OF CHANNELS	BANDWIDTH	SYSTEM GAIN*	PREAMP NOISE FIGURE	PREAMP 3RD ORDER OUTPUT INTERCEPT POINT	POWER REQUIREMENT	DC BACKUP	CONNECTORS (IN/OUT)	DIMENSIONS	TEMP RANGE
42-33-01-04N	4	118-174 MHz	12 dB	2.0 dB	+41 dBm	85-264 VAC, 47-63 Hz	22-30 V	N / N	1.75"H x 19"W x 14"D	0-50 C
42-33-01-08N	8	118-174 MHz	15 dB	2.0 dB	+41 dBm	85-264 VAC, 47-63 Hz	22-30 V	N / N	1.75"H x 19"W x 14"D	0-50 C
42-33-01-12N	12	118-174 MHz	15 dB	2.0 dB	+41 dBm	85-264 VAC, 47-63 Hz	22-30 V	N / N	1.75"H x 19"W x 14"D	0-50 C
42-33-01-08	8	118-174 MHz	13 dB	2.0 dB	+41 dBm	85-264 VAC, 47-63 Hz	22-30 V	N / BNC	1.75"H x 19"W x 14"D	0-50 C
42-33-01	16	118-174 MHz	12 dB	2.0 dB	+41 dBm	85-264 VAC, 47-63 Hz	22-30 V	N / BNC	1.75"H x 19"W x 14"D	0-50 C
42-57-01-04N	4	380-520 MHz	12 dB	2.2 dB	41 dBm	85-264 VAC, 47-63 Hz	22-30 V	N / N	1.75"H x 19"W x 14"D	0-50 C
42-57-01-08N	8	380-520 MHz	15 dB	2.2 dB	41 dBm	85-264 VAC, 47-63 Hz	22-30 V	N / N	1.75"H x 19"W x 14"D	0-50 C
42-57-01-12N	12	380-520 MHz	15 dB	2.2 dB	41 dBm	85-264 VAC, 47-63 Hz	22-30 V	N / N	1.75"H x 19"W x 14"D	0-50 C
42-57-01-08	8	380-520 MHz	13 dB	2.2 dB	41 dBm	85-264 VAC, 47-63 Hz	22-30 V	N / BNC	1.75"H x 19"W x 14"D	0-50 C
42-57-01	16	380-520 MHz	12 dB	2.2 dB	41 dBm	85-264 VAC, 47-63 Hz	22-30 V	N / BNC	1.75"H x 19"W x 14"D	0-50 C
42-83A-01-04N	4	746-901 MHz	22 dB	0.8 dB	39 dBm	85-264 VAC, 47-63 Hz	22-30 V	N / N	1.75"H x 19"W x 14"D	0-50 C
42-83A-01-08N	8	746-901 MHz	19 dB	0.8 dB	39 dBm	85-264 VAC, 47-63 Hz	22-30 V	N / N	1.75"H x 19"W x 14"D	0-50 C
42-83A-01-12N	12	746-901 MHz	16 dB	0.8 dB	39 dBm	85-264 VAC, 47-63 Hz	22-30 V	N / N	1.75"H x 19"W x 14"D	0-50 C
42-83A-01-08	8	746-901 MHz	19 dB	0.8 dB	39 dBm	85-264 VAC, 47-63 Hz	22-30 V	N / BNC	1.75"H x 19"W x 14"D	0-50 C
42-83A-01	16	746-901 MHz	16 dB	0.8 dB	39 dBm	85-264 VAC, 47-63 Hz	22-30 V	N / BNC	1.75"H x 19"W x 14"D	0-50 C

* Attenuator pads are provided to reduce system gain for performance optimization

ACCESSORIES

Model Number	Description	Connector
83-01-01	1/4 W Termination	N male
83-01-05	1/4 W Termination	BNC male
87-01-01	3 dB Fixed Attenuator	BNC
87-01-02	6 dB Fixed Attenuator	BNC
87-01-03	10 dB Fixed Attenuator	BNC

tel: 866.695.4569 fax: 716.549.4772 e: sales@bird-technologies.com

RECEIVER MULTICOUPLERS

Expansion Kits

100-1000 MHz

EXPANSION KIT MODELS

	Frequency (MHz)	Model No.	Expansion From	To	Shipping Weight (lbs)	Figure No.
2ND GENERATION	100-512	75-01-14	4	8	3	1
	100-512	75-01-15	8	12	3	2
	100-512	75-01-16	12	16	3	3
	100-512	75-05-02	8	16	3	4
	100-512	75-05-01	16	32	7	5
	746-901	75-83A-02	4	8	3	1
	746-901	75-83A-03	8	12	3	2
	746-901	75-83A-04	12	16	3	3
	746-901	75-83A-05	8	16	3	4
	746-901	75-83A-01	16	32	7	5
	132-512	75-01-10	4	8	3	6 or 7
132-512	75-01-11	8	12	5	8	
132-512	75-01-12	12	16	3	10	
132-512	75-01-13	16	20	6	11	
132-512	75-01-12	20-28	+4	3	12	
LEGACY	406-512	75-67-01*	8	12	5	9
	800-1000	75-90-01	4	8	3	6 or 7
	800-1000	75-90-02*	8	12	6	9
	800-1000	75-90-03	8	12	5	8
	800-1000	75-90-04	12	16	3	10
	800-1000	75-90-05	16	20	6	11
	800-1000	75-90-04	20-28	+4	3	12

SYMBOL KEY

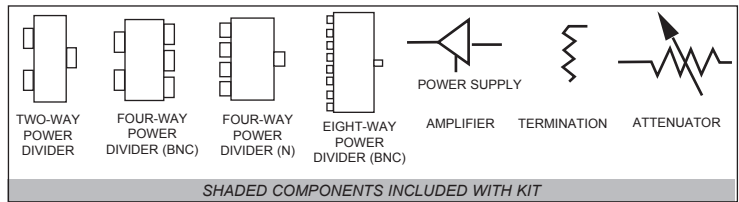

Notes: *Receiver multicouplers may be ordered with single stage or dual stage amplifiers. Expansion kit model number with asterisk indicates second preamplifier stage is included. As per table below, second stage peramplifiers may be ordered separately.

SINGLE TO DUAL STAGE AMP KIT

Range	Model No.	Tuned Sub-band
132-174	86-38-12-E	20 MHz
406-512	86-67-12-E	60 MHz
800-1000	86-85-11-E	800-900 or 900-1000 MHz

EXPANSION KITS FOR 2ND GENERATION RX MULTICOUPLERS

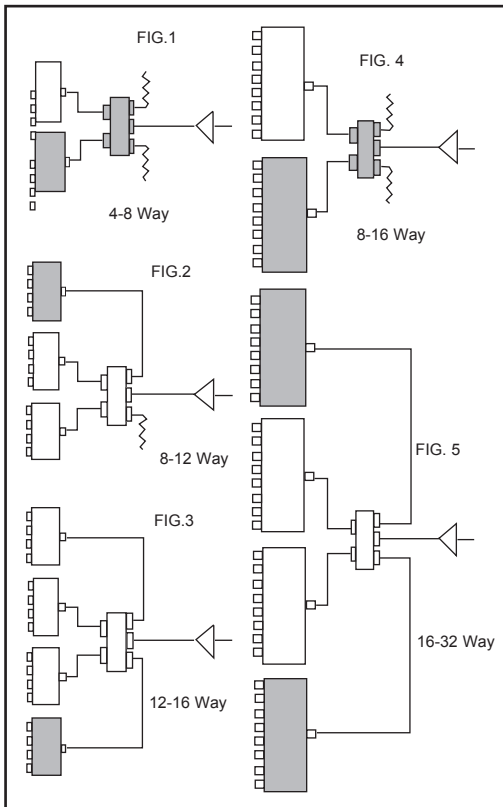

EXPANSION KITS FOR LEGACY RX MULTICOUPLERS

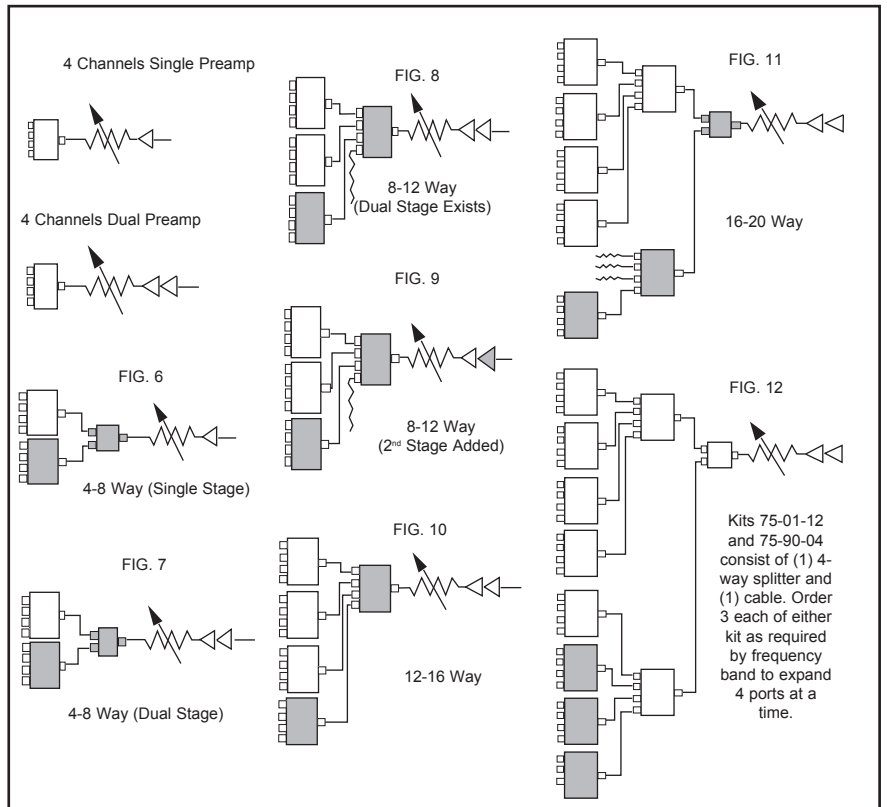

PRESELECTORS

132-890 MHz

PRESELECTORS/POST FILTERS

Bird Technologies Group, TX RX Systems brand has designed application-specific multi-cavity filter products for use in limiting the bandwidth in front of a multiple-receiver system (Preselector) or after a multiple-transmitter system (Post Selector). Size and complexity range from a model built from three helically-loaded 1.3-inch rectangular resonators for relatively low-selectivity receive-only applications, where 2 dB of loss can be tolerated, to four 6.625-inch cavities that can handle 400 watts with high selectivity and loss of 1 dB or less. The most popular models are built from four 4-inch cavities, exhibit medium to high selectivity, depending upon the center frequency, and can handle 125 watts of power with 1.2 to 1.8 dB of loss.

The 4 and 6-inch cavity models can be ordered with pass bandwidths ranging from 0.5 to 2 MHz. The typical curves show how different bandwidths affect isolation and insertion loss. Generally, a narrower bandwidth results in a higher insertion loss and selectivity than a wider bandwidth.

Several models available to match your specific application

All filters are factory tuned to meet specific frequency channel requirements

Temperature compensation keeps product tuned to specification from -30 to +60° C



89-37-13A

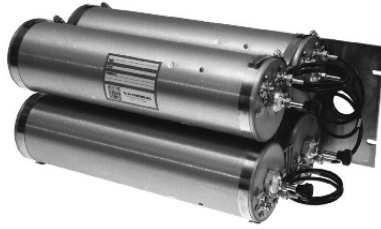

89-37-06C



89-37-06A

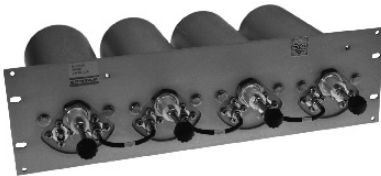

89-70-01A

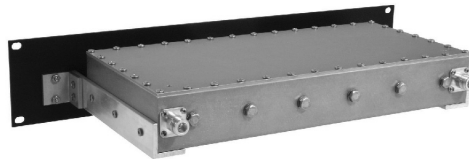

89-56-05A



89-70-27A

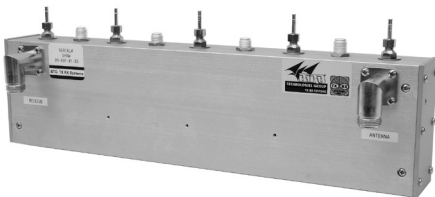

89-83F-01-03

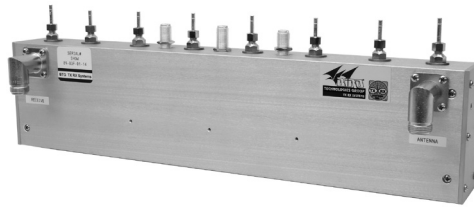

89-83F-01-014

PRESELECTORS

Technical Specifications

Model Number	89-36-03A	89-37-01K	89-37-06A	89-37-06C	89-37-13A
Frequency Range (MHz)	132-150	144-174	144-174	144-174	144-174
No. of Cavities/Resonators	4 x 4"	3 x LC	4 x 4"	4 x 4"	4 x 6.625"
Pass Bandwidth (MHz)	0.5 to 2.0	4-10	0.5 to 2.0	0.5 to 2.0	0.5 x 2.0
Specification Bandwidth (MHz)	1.0	1.0	1.0	1.0	1.0
Insertion Loss (dB) @ F _o (MHz)	1.2 @ 140	1.5 @ 155	1.4 @ 160	1.4 @ 160	0.7 @ 160
Passband Insertion Loss (dB)	1.6	2.0	1.8	1.8	1.0
Typical Selectivity (dB @ MHz)	58 @ 135	30 @ 140	65 @ 155	65 @ 155	73 @ 155
Typical Selectivity (dB @ MHz)	78 @ 145	20 @ 170	78 @ 165	78 @ 165	76 @ 165
Return Loss, dB (VSWR)	20 (1.22:1)	14 (1.5:1)	20 (1.22:1)	20 (1.22:1)	20 (1.22:1)
RF Power (Watts)	125	Rx only	125	125	400
Tempature Range, °C	-30 to +60	-30 to +60	-30 to +60	-30 to +60	-30 to +60
Connectors, Antenna/Output	BNC	N / BNC	BNC	BNC	N / N
Dimensions, HxWxD (inches)	5.25x19x22	1.5x4.5x2.5	5.25x19x20	9.5x19x10.5	33x19x15
Dimensions, HxWxD (mm)	133x483x559	38x115x64	133x483x508	241x483x267	838x483x381
Mounting	19"	Surface	19"	19"	19"
Shipping Weight, lb (kg)	21 (9.5)	3 (1.4)	19 (8.6)	23 (10.4)	50 (22.6)

Model Number	89-56-05A	89-65-01A	89-65-12A	89-66-02A	89-68-06A
Frequency Range (MHz)	380-420	406-430	406-430	430-450	450-512
No. of Cavities/Resonators	6	4 x 4"	3 x 2"	3 x 2"	8-Resonator
Pass Bandwidth (MHz)	5	0.5 to 2.0	1.0	1.0	2
Specification Bandwidth (MHz)	5	1.0	1.0	1.0	2
Typical Insertion Loss (dB)	1.5	1.6	2.5	2.7	2.5
Max Ins Loss @ Passband Edge (dB)	1.5	2.0	3.0	3.5	4
Typical Selectivity (dB @ MHz)	80 @ Paired Tx	60 @ ±4.5	45 @ ±5.0	45 @ ±5.0	70 @ ±2
Return Loss, dB (VSWR)	18 (1.29:1)	17 (1.32:1)	17 (1.32:1)	17 (1.32:1)	12 (1.66:1)
RF Power (Watts)	Receive Only	200	Receive Only	Receive Only	Receive Only
Tempature Range, °C	-30 to +60	-30 to +60	-30 to +60	-30 to +60	-30 to +60
Connectors	N	BNC	BNC	BNC	N
Dimensions, HxWxD (inches)	3.5x19x8	4x19x10.5	2x19x9	2x19x8	7x19x10
Dimensions, HxWxD (mm)	80x483x203	102x483x267	51x483x229	51x483x203	178x483x254
Mounting	19" **	19" **	19" **	19" **	19" **
Shipping Weight, lb (kg)	10 (4.5)	6 (2.7)	3 (1.4)	3 (1.4)	13 (5.9)

Model Number	89-70-01A	89-70-24A	89-70-27A	89-70-28A
Frequency Range (MHz)	450-470	450-470	450-470	456-460/466-470
No. of Cavities/Resonators	4 x 4"	3 x 2"	8-Resonator	Dual 8-Resonator
Pass Bandwidth (MHz)	0.5 x 2.0	1.0	4	4/4
Specification Bandwidth (MHz)	1.0	1.0	4	4/4
Typical Insertion Loss (dB)	1.6	2.5	2.5	4.0
Max Ins Loss @ Passband Edge (dB)	2.0	3.1	4	5.6
Typical Selectivity (dB @ MHz)	60 @ ±4.5	45 @ ±5.0	40 @ ±3.0	40 @ ±3.0
Return Loss, dB (VSWR)	17 (1.32:1)	17 (1.32:1)	12 (1.66:1)	12 (1.66:1)
RF Power (Watts)	200	Receive Only	Receive Only	Receive Only
Temperature Range, °C	-30 to +60	-30 to +60	-30 to +60	-30 to +60
Connectors	BNC	BNC	N	N
Dimensions, HxWxD (inches)	9.5x19x10.5	2x19x8.75	7x19x10	14x19x10
Dimensions, HxWxD (mm)	241x483x267	51x483x222	178x483x254	356x483x254
Mounting	19" **	19" **	19" **	19" **
Shipping Weight, lb (kg)	14 (6.3)	3 (1.4)	13 (5.9)	27 (12.2)

** EIA rack mount

^^ Cross Mount

-20- Preselectors are supplied with 24" RG-142B/u N(M) to SMA(M) cable

tel: 866.695.4569 fax: 716.549.4772 e: sales@bird-technologies.com

BIRD TECHNOLOGIES GROUP RESERVES THE RIGHT TO MODIFY SPECIFICATIONS OR DISCONTINUE ANY PRODUCT WITHOUT NOTICE TERMS AND CONDITIONS POSTED ON [HTTP://WWW.BIRD-TECHNOLOGIES.COM/SALES/BTG_TC.PDF](http://www.bird-technologies.com/sales/btg_tc.pdf) 10

PRESELECTORS

Technical Specifications

Model Number	89-83C-01-32	89-86A-20-03	89-86A-20-05	89-86A-20-10	89-86A-20-15
Frequency Range (MHz)	792-824	806-824	806-824	806-824	806-824
No. of Cavities/Resonators	2	5	6	8	8
Pass Bandwidth (MHz)	32	3	5	10	15
Specification Bandwidth (MHz)	32	3	5	10	15
Typical Insertion Loss (dB)	1.5	2.0	1.3	1.0	1.0
Max Ins Loss @ Passband Edge (dB)	1.5	2.0	1.3	1.0	1.0
Typical Selectivity (dB @ MHz)	110 @ 766 & 851	100 @ 851	100 @ 851	100 @ 851	72 @ 851
VSWR max.	1.5:1	1.5:1	1.5:1	1.5:1	1.5:1
RF Power (Watts)	Rx only	Rx only	Rx only	Rx only	Rx only
Temperature Range, °C	-30 to +60	-30 to +60	-30 to +60	-30 to +60	-30 to +60
Connectors	N	N	N	N	N
Dimensions, HxWxD (inches)	3.5 x 19 x 7	3.5 x 19 x 5	3.5 x 19 x 5	3.5 x 19 x 5	3.5 x 19 x 5
Dimensions, HxWxD (mm)	89x483x178	89x483x127	89x483x127	89x483x127	89x483x127
Mounting	19" **	19" **	19" **	19" **	19" **
Shipping Weight, lb (kg)	8 (3.6)	6 (2.7)	6 (2.7)	6 (2.7)	6 (2.7)

Model Number	89-86A-20-18	89-86A-21-03	89-86A-21-05	89-86A-21-10	89-86A-21-15
Frequency Range (MHz)	806-824	806-824	806-824	806-824	806-824
No. of Cavities/Resonators	10	5	6	8	8
Pass Bandwidth (MHz)	18	3	5	10	15
Specification Bandwidth (MHz)	18	3	5	10	15
Typical Insertion Loss (dB)	1.0	2.0	1.3	1.0	1.0
Max Ins Loss @ Passband Edge (dB)	1.0	2.0	1.3	1.0	1.0
Typical Selectivity (dB @ MHz)	100 @ 851	100 @ 851	100 @ 851	100 @ 851	72 @ 851
VSWR max.	1.5:1	1.5:1	1.5:1	1.5:1	1.5:1
RF Power (Watts)	Rx only	Rx only	Rx only	Rx only	Rx only
Temperature Range, °C	-30 to +60	-30 to +60	-30 to +60	-30 to +60	-30 to +60
Connectors	N	N	N	N	N
Dimensions, HxWxD (inches)	3.5 x 19 x 5	3.5 x 19 x 5	3.5 x 19 x 5	3.5 x 19 x 5	3.5 x 19 x 5
Dimensions, HxWxD (mm)	89 x 483 x 127	89 x 483 x 127	89 x 483 x 127	89 x 483 x 127	89 x 483 x 127
Mounting	19" **	19" **	19" **	19" **	19" **
Shipping Weight, lb (kg)	6 (2.7)	6 (2.7)	6 (2.7)	6 (2.7)	6 (2.7)

Model Number	89-86A-21-18	89-87-05P	89-87A-05P	89-87A-05DIN	89-92-01P	89-93-02P
Frequency Range (MHz)	806-824	851-866	851-869	851-869	825-845	870-890
No. of Cavities/Resonators	10	4	4	4	6	6
Pass Bandwidth (MHz)	18	15	18	18	10	10
Specification Bandwidth (MHz)	18	15	18	18	10	10
Typical Insertion Loss (dB)	1.0	0.3	0.5	0.5	0.6	0.6
Max Ins Loss @ Passband Edge (dB)	1.0	0.35	0.5	0.5	1.0	1.0
Typical Selectivity (dB @ MHz)	100 @ 851	40 @ 821	30 @ 824	30 @ 824	95 @ 870	85 @ 835
VSWR max.	1.5:1	1.2:1	1.2:1	1.2:1	1.5:1	1.5:1
RF Power (Watts)	Rx only	600	600	600	Rx only	Rx only
Temperature Range, °C	-30 to +60	-30 to +60	-30 to +60	-30 to +60	-30 to +60	-30 to +60
Connectors	N	N	N	DIN	N	N
Dimensions, HxWxD (inches)	3.5 x 19 x 5	5.25 x 19 x 2	5.25 x 19 x 2	5.25 x 19 x 2	5.25 x 19 x 2.5	5.25 x 19 x 2.5
Dimensions, HxWxD (mm)	89 x 483 x 127	135 x 483 x 51	135 x 483 x 51	135 x 483 x 51	133 x 483 x 64	133 x 483 x 64
Mounting	19" **	19" **	19" **	19" **	19" **	19" **
Shipping Weight, lb (kg)	6 (2.7)	8.3 (3.8)	8.3 (3.8)	8.3 (3.8)	6.8 (3.1)	6.8 (3.1)

** EIA rack mount

^^ Cross Mount

-20- Preselectors are supplied with 24" RG-142B/u N(M) to SMA(M) cable

tel: 866.695.4569 fax: 716.549.4772 e: sales@bird-technologies.com

PRESELECTORS

Technical Specifications

Models 89-36-03A (0.5, 1.0, 2.0 MHz BW)

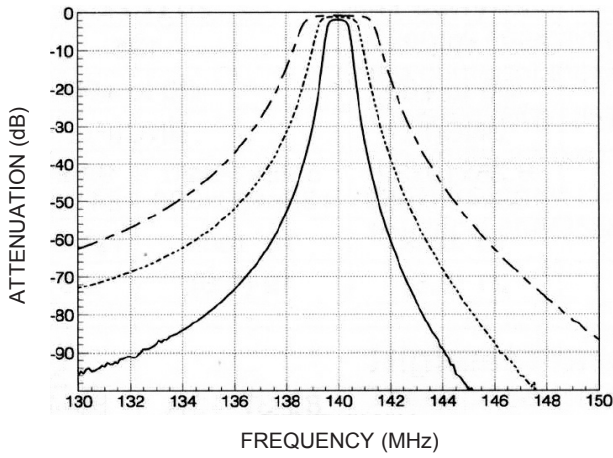

Models 89-37-01K

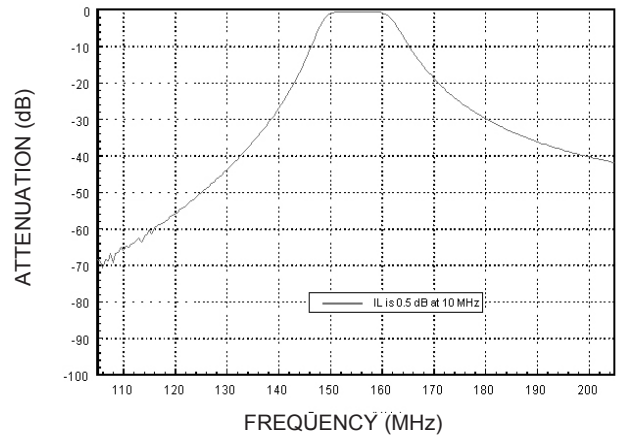

Models 89-37-06A, -06C (0.5, 1.0, 2.0 MHz BW)

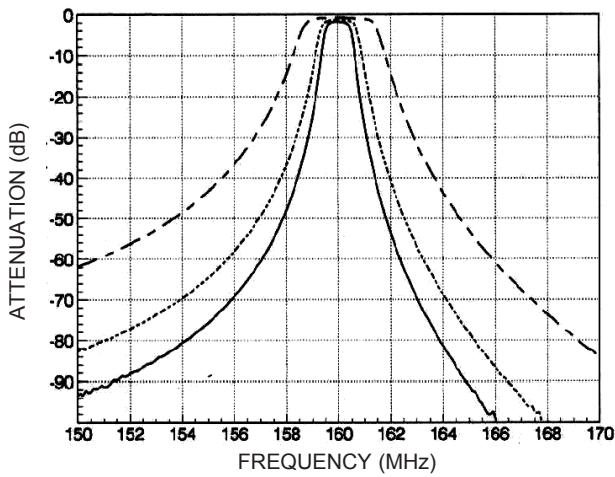

Models 89-37-13A (0.5, 1.0, 2.0 MHz BW)

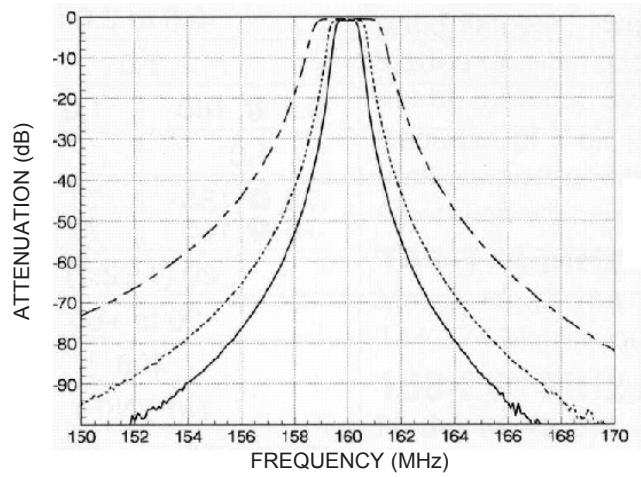

Model 89-65-01A
(Fo=418 MHz, 0.5 - 2 MHz BW)

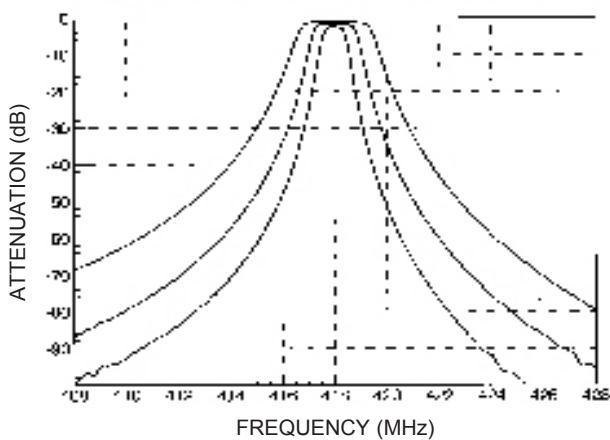

Model 89-70-27A

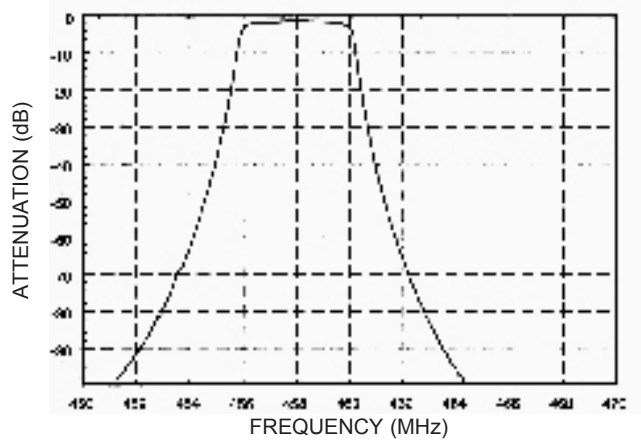

PRESELECTORS

Technical Specifications

Preselector Model 89-56-05A

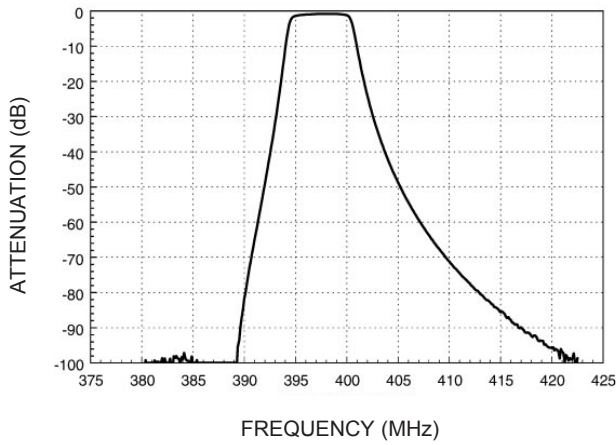

Model 89-70-01A
($F_o=460$ MHz, 0.5, 1.0, 2.0 MHz BW)

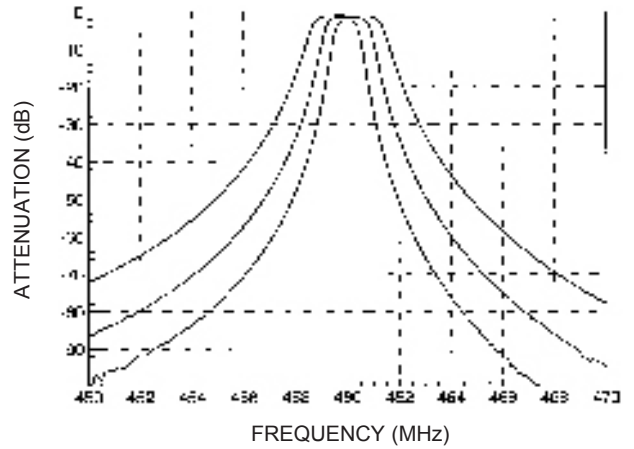

Model 89-83C-01-32

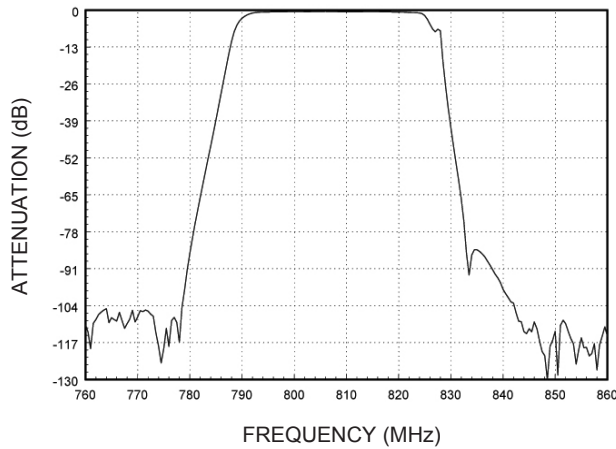

Model 89-83F-01-3 and 89-83F-01-06

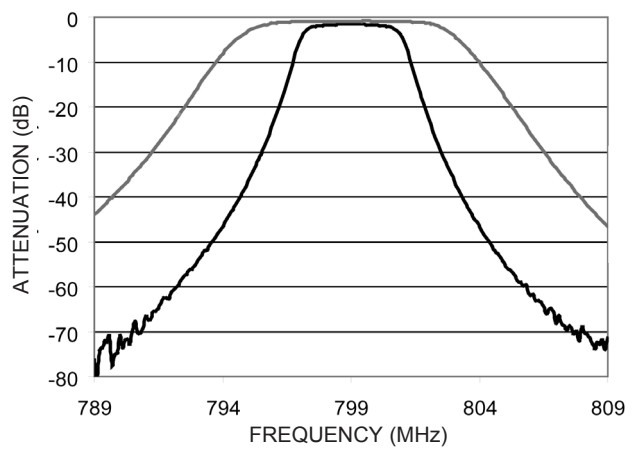

Model 89-87A-05P

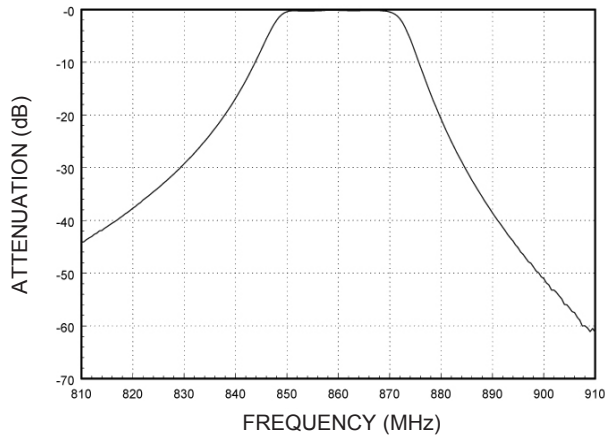

Model 89-87-05P

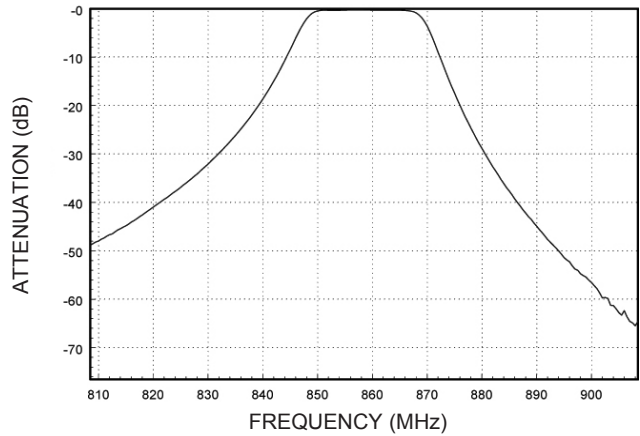

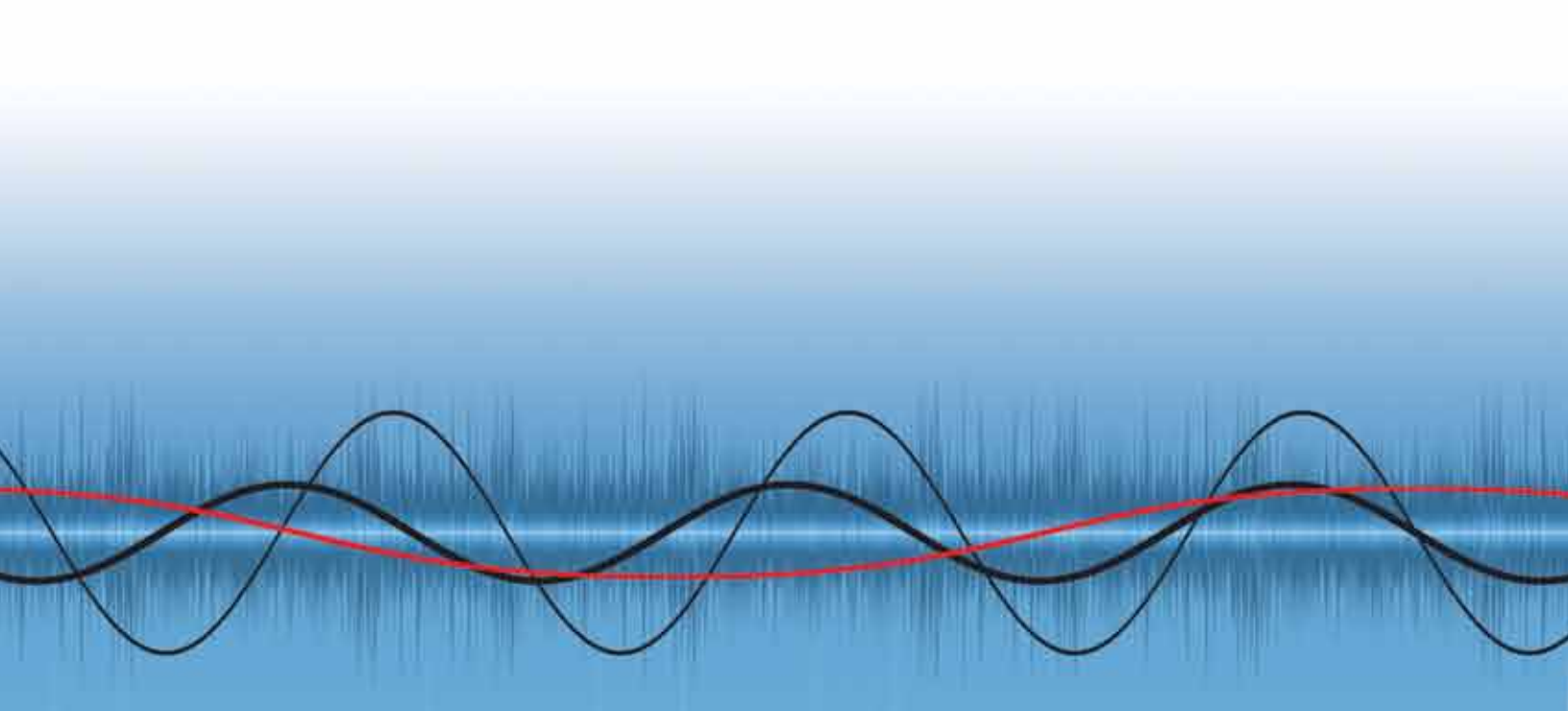

Bird Technologies (Bird) has been the industry's standard in radio frequency product reliability for 70 years. Bird is an industry leading provider of RF communications products, services, calibration, and training to the Public Safety, Cellular Communications, Broadcast, Semiconductor, Military, Government and Medical markets.

The products and services offered by Bird have expanded to meet the challenges of today's complex communications systems and include Spectrum and Site Analyzers, Antennas, Combining Systems, Components, Duplexers and Triplexers, Filters, Loads and Attenuators, Power Sensors and Meters, Power Monitors, Signal Boosters, Tower Top Amplifiers and Receiver Multicouplers, RF data capture & storage, RF signal generation, and software analysis tools. The company is positioned to continue its rich heritage with the next generations of high quality, reliable, field tested products – and the world's most reliable RF.

All Bird products can be serviced and calibrated by the **Bird Service Center (BSC)**. Bird Service Centers and Service Partners are located World Wide providing a full range of service and support for your Bird Products.

To view the catalog online or download, go to www.birdrf.com



30303 Aurora Rd. :: Solon, OH 44139 :: 866.695.4569 :: www.birdrf.com

